

Sale Model:

CPG012CA(I)

Power Supply:

115V_1Ph,FREQUENCY_60HZ

Export Time:

2016-02-26 14:57:49

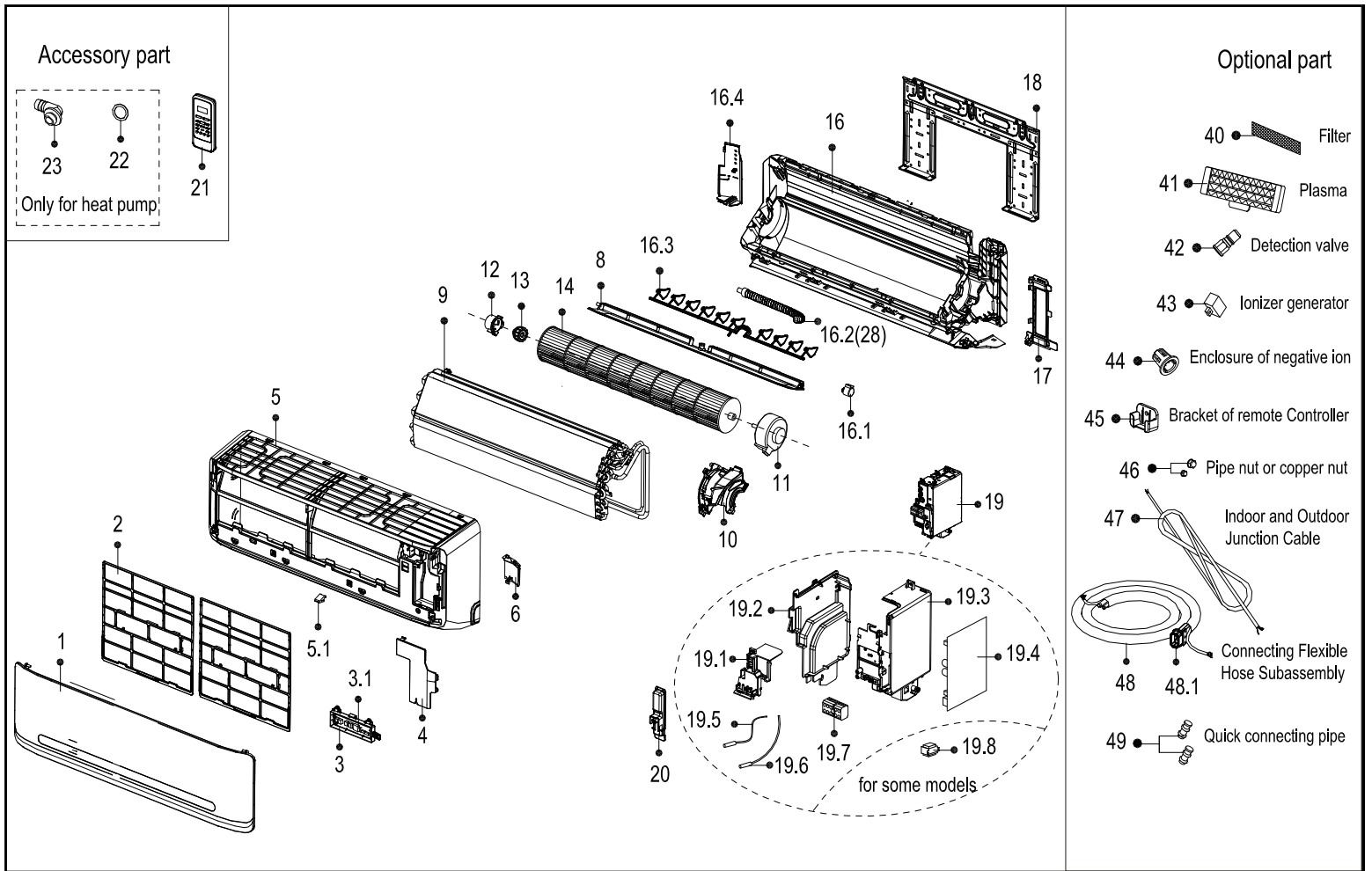

No.	Part Name	Quantity	BOM Code
1	Panel assembly	1	12122000A29998
2	Air filter	2	12100204000522
3	Display box assembly	1	17222000A08319
3.1	Display board assembly	1	17122000A09004
4	Cover of electrical equipment	1	12122000006755
5	Panel frame assembly	1	12122000001726
6	Right cover of chassis	1	12122000004587
8	Horizontal louver assembly	1	12122000005815
9	Evaporator assembly	1	15822000003601
10	Fan motor cover	1	12122000005540
11	Fan motor	1	11002015000031
12	Bearing holder	1	12122000000350
13	Bearing base	1	12622000000006
14	Cross flow fan	1	12100102000044
16	Chassis assembly	1	12122000011818
16.1	Louver motor	1	11002010000143
16.3	Vertical vane	1	12122000000038
16.4	Left cover of chassis	1	12122000010098
17	Pipe clamp board	1	12122000012943

No.	Part Name	Quantity	BOM Code
18	Installation plate	1	12222000000018
19	Electronic control box assembly	1	17222000009828
19.1	Top cover of electronic control box	1	12122000004577
19.2	Left side plate of Electronic control box	1	12122000004639
19.3	Right side plate of Electronic control box	1	12122000004632
19.4	Indoor main control board assembly	1	17122000019350
19.5	Ambient temperature sensor assembly	1	11201007000085
19.6	Pipe temperature sensor assembly	1	11201007000322
19.7	Wire joint	1	17400401000006
20	Cover of electronic control box	1	12122000005020
21	Remote Controller	1	17317000A16345
22	Seal ring	1	12600701000039
23	Drain joint	1	12100509000061
28	Drain hose	1	12100501000032
40	Air freshening filter	1	12100204000685
45	Bracket of remote Controller	1	12117000A00041
46	Pipe nut or copper nut	1	15500406000012
46	Pipe nut or copper nut	1	15500406000016